

906

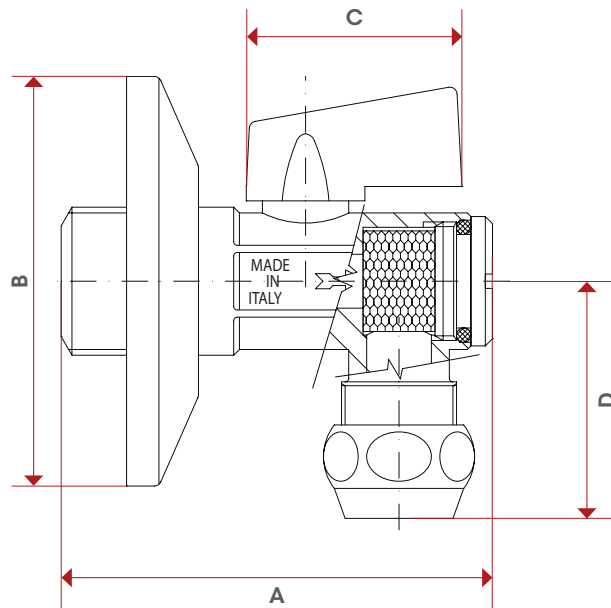

TEC



	1/2"
DN	15
A	60
B	57
C	30
D	33
Kg/cm ² bar	8
LBS - psi	116