

340

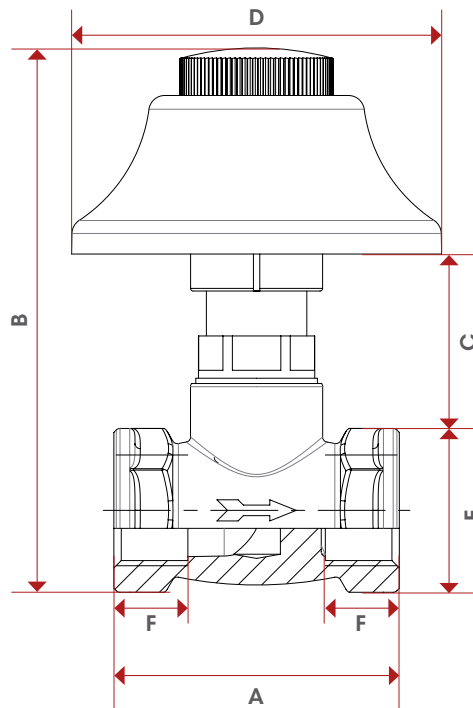

TEC



	1/2"	3/4"
DN	15	20
A	54	59,5
B	103	107,5
C	33	33
D	70	70
E	31	35,5
F	14	14
Kg/cm ² bar	20	15
LBS - psi	290	217,5